

MDCA Series



FEATURES

- Shielded construction.
- Capable of corresponding high frequency.
- Low loss realized with low DCR.
- High performance (Isat) realized by Carbonyl Powder.
- Ultra low buzz noise, due to composite construction.
- 100% Lead(Pb)-Free and RoHS compliant.
- AEC-Q200 qualified
- Operating temperature: -55 to +125 °C(including self-temperature rise)
- Quantity:500pcs

APPLICATION

- Headlamps, tail lamps and interior lighting
-
- Doors, window lift and seat control
-
-
- In-Vehicle Infotainment and navigation

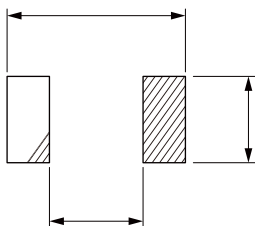
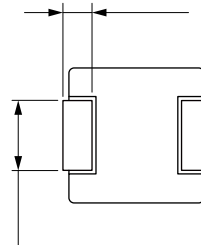
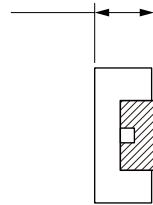
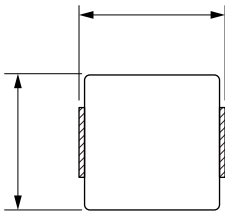

Part No	Inductance @ 100KHz/1V	Tolerance			DC Resistance Typ.	DC Resistance Max.
MDCA1365-R15M	0.15		55.0	118.0	0.49	0.60
MDCA1365-R22M	0.22		53.0	112.0	0.47	0.60
MDCA1365-R33M	0.33		46.0	68.0	0.65	0.80
MDCA1365-R36M	0.36		45.0	66.0	0.70	0.90
MDCA1365-R47M	0.47		41.0	63.0	0.90	1.20
MDCA1365-R56M	0.56		37.0	58.0	1.05	1.20
MDCA1365-R68M	0.68		35.0	55.0	1.25	1.50
MDCA1365-R82M	0.82		33.0	50.0	1.50	1.90
MDCA1365-1R0M	1.00		30.0	48.0	1.70	2.30
MDCA1365-1R5M	1.50		27.0	45.0	2.50	3.00
MDCA1365-2R2M	2.20		22.0	37.0	3.80	4.20
MDCA1365-3R3M	3.30		18.0	30.0	5.70	6.80
MDCA1365-4R7M	4.70		13.5	28.0	7.00	8.40
MDCA1365-5R6M	5.60		12.5	23.0	8.50	10.0
MDCA1365-6R8M	6.80		11.5	18.0	9.50	11.5
MDCA1365-8R2M	8.20		10.5	16.0	12.0	15.5
MDCA1365-100M	10.0		10.0	15.5	13.2	16.5
MDCA1365-150M	15.0		9.0	13.0	23.2	28.0
MDCA1365-220M	22.0		9.0	12.0	32.5	37.0
MDCA1365-330M	33.0		8.0	11.0	48.0	58.0
MDCA1365-470M	47.0		6.5	9.5	76.0	90.0
MDCA1365-680M	68.0		4.8	7.8		
MDCA1365-101M			4.2	5.5	145	165

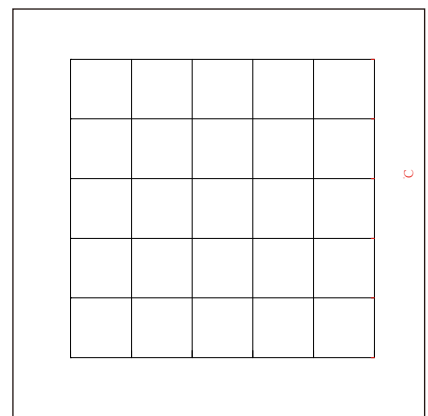
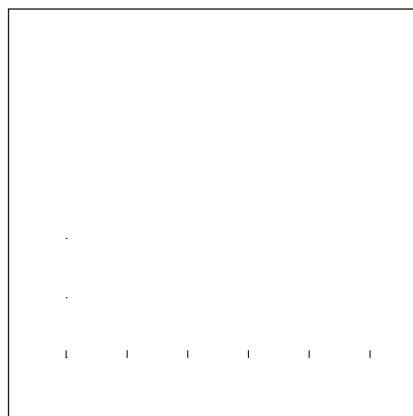
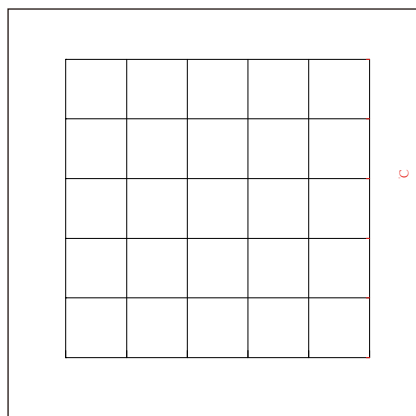

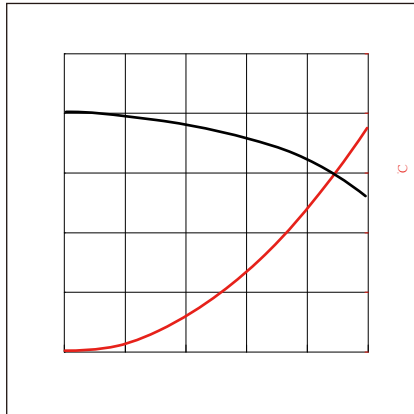
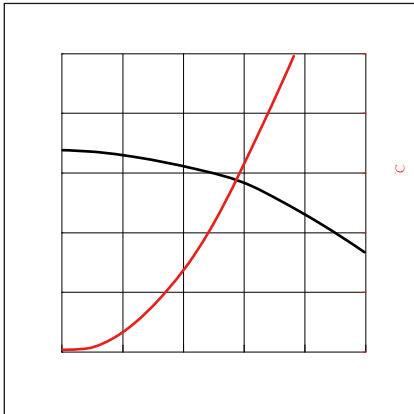
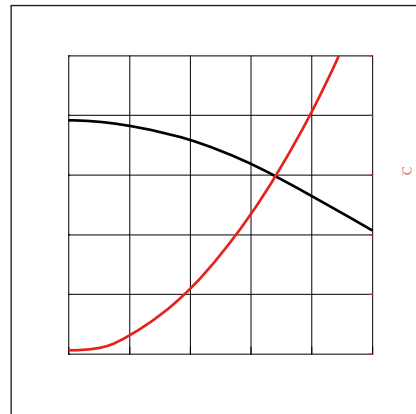
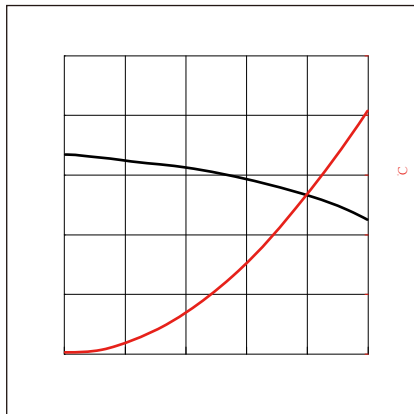
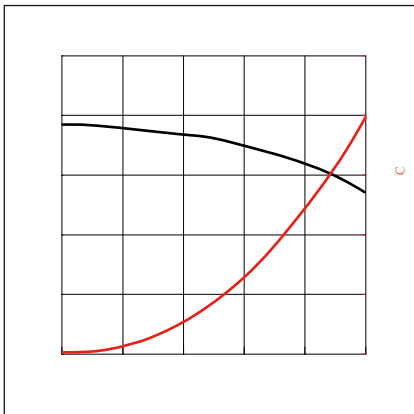
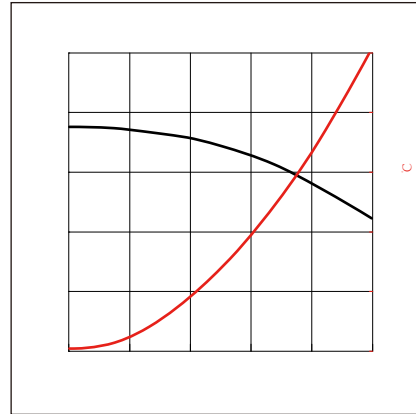
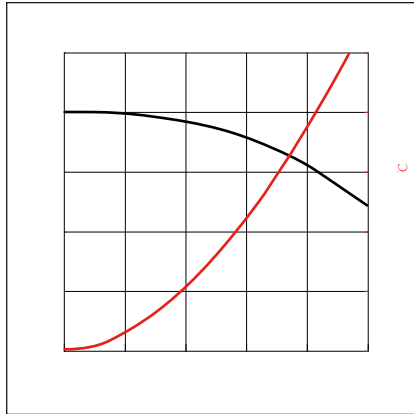
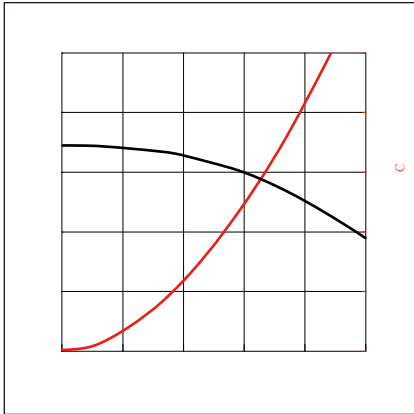

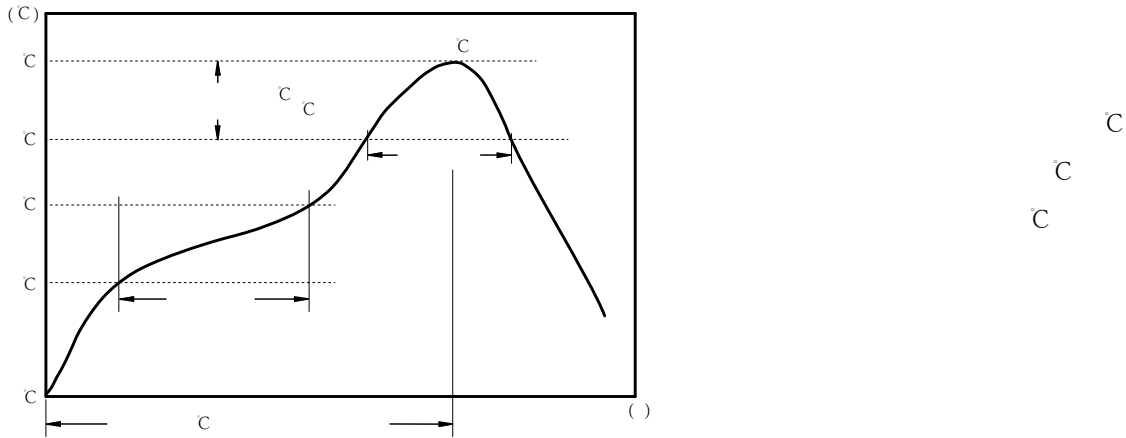

:

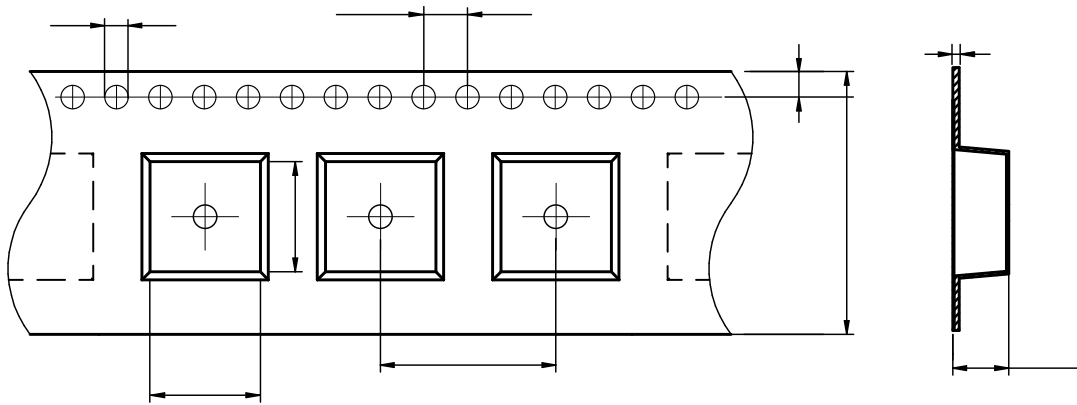

MDCA1365	13.0 typ.	14.0 typ.	1.5±0.1	4.0±0.1	16.0±0.1	24.0±0.3	6.9 typ.	1.75±0.1	0.40 typ.

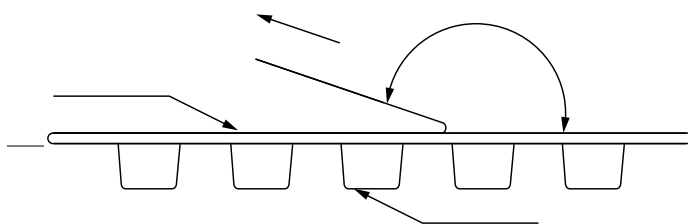

The peel force of top cover tape shall be between 0.1 to 1.3 N

:

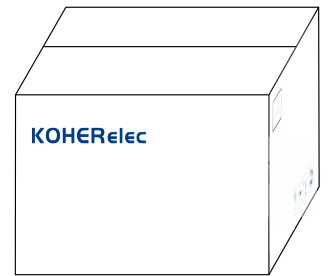
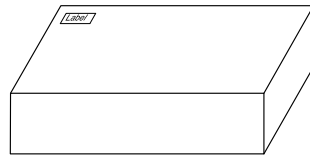
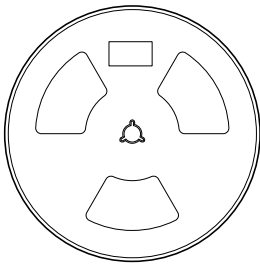
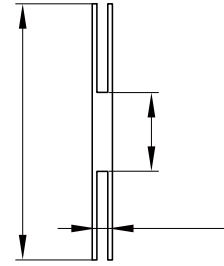
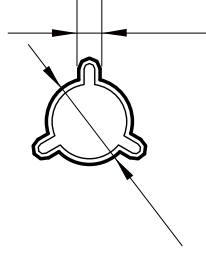
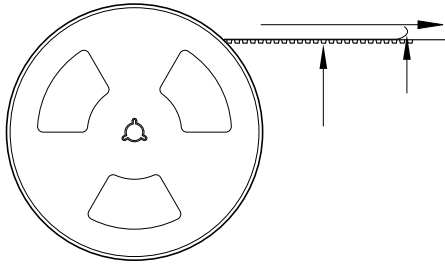

500 Pcs/Reel

2 Reel /Inner box(1000 Pcs)

2 Inner box/Carton box(2K Pcs)

:

-
-
-
-
-
-
-
-
-